

**SAFEMASTER**  
Interface Modules  
LG 3096, MK 3096N

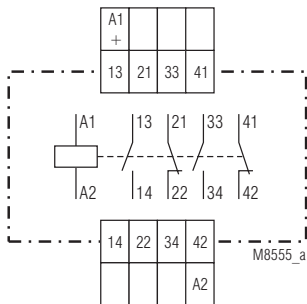

- With **forcibly guided** contacts according to IEC 61810-3
- Max. 6 contacts
- As option goldplated contacts to switch low loads
- Wire connection: also 2 x 1.5 mm<sup>2</sup> stranded ferruled, or 2 x 2.5 mm<sup>2</sup> solid DIN 46 228-1/-2/-3/-4
- As option with pluggable terminal blocks for easy exchange of devices
  - with screw terminals
  - or with cage clamp terminals
- Width 22.5 mm

**Circuit Diagrams**



LG 3096.52  
MK 3096N.52

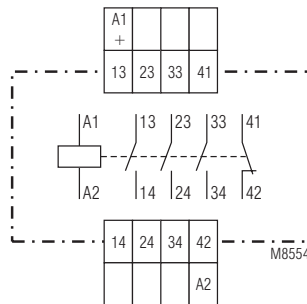

LG 3096.48  
MK 3096N.48

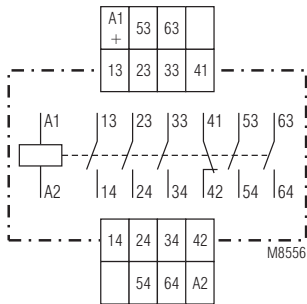

LG 3096.60  
MK 3096N.60

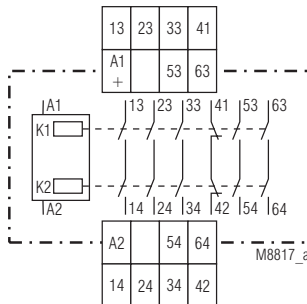

MK 3096N.60/100

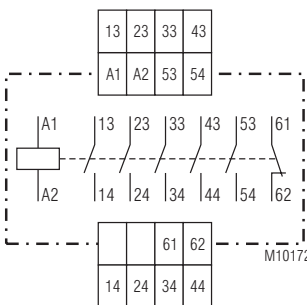

LG 3096.60/300

**Approvals and Markings**



\* see variants

**Application**

- Switching device with the possibility to monitor the contact status via forcibly guided NC contacts.

**Connection Terminals**

Terminal designation	Signal designation
A1 / A2	Supply voltage
13, 14, 23, 24, 33, 34, 43, 44, 53, 54, 63, 64	Forcibly guided NO contacts
21, 22, 41, 42, 61, 62	Forcibly guided NC contacts

## Technical Data

### Input

#### Nominal voltage $U_N$ :

LG 3096: DC 24, 48 V; AC 100, 230 V

MK 3096: DC 24, 48 V

**Voltage range:** 0.8... 1.1  $U_N$

**Nominal consumption** 0.6 W

### Output

#### Contacts:

MK 3096.52, LG 3096.52: 2 NO and 2 NC contacts

MK 3096.48, LG 3096.48: 3 NO and 1 NC contacts

MK 3096.60, LG 3096.60: 5 NO and 1 NC contacts

**Contact type:** forcibly guided

**Operate time:** typical 20 ms

**Release time:** typical 15 ms

**Nominal output voltage:** AC 250 V

**Thermal current  $I_{th}$**  5 A

#### Switching capacity

to AC 15

NO contacts: 3 A / AC 230 V IEC/EN 60 947-5-1

NC contacts: 2 A / AC 230 V IEC/EN 60 947-5-1

to DC 13

NO contacts: 1 A / DC 24 V IEC/EN 60 947-5-1

NC contacts: 1 A / DC 24 V IEC/EN 60 947-5-1

to DC 13

(switching frequency: 0.1 Hz): 0,5 A / DC 110 V

4 A / DC 24 V

2 contacts in series: 1 A / DC 110 V

MK 3096N/100: 1 A / DC 110 V

2 contacts in series: 4 A / DC 110 V

#### Electrical life

IEC/EN 60 947-5-1

NO contacts:

to AC 15 at 3 A, AC 230 V: 1.5 x 10<sup>5</sup> switching cycles

NO contacts:

to AC 15 at 2 A, AC 230 V: 3 x 10<sup>5</sup> switching cycles

NC contacts:

to AC 15 at 2 A, AC 230 V: 1 x 10<sup>5</sup> switching cycles

#### Permissible switching

**frequency:** 10 switching cycles / s

**Switching voltage min./max.:** AC/DC 10 V / DC 250 V, AC 400 V

**Switching current min./max.:** 10 mA / 5 A

**Switching capacity min./max.:** 3 VA / 1250 VA

3 W / 200 W

#### Short circuit strength

**max. fuse rating:**

LG 3096: 10 A gL IEC/EN 60 947-5-1

MK 3096N: 10 A gL IEC/EN 60 947-5-1

**Mechanical life:** ≥ 20 x 10<sup>6</sup> switching cycles

### General Data

#### Operating mode:

Continuous operation

#### Temperature range:

Operation: - 20 ... + 60°C

Storage: - 40 ... + 60°C

**Altitude:** < 2.000 m

#### Clearance and creepage distances

rated impulse voltage / pollution degree: 4 kV / 2 IEC 60 664-1

#### EMC

Electrostatic discharge: 8 kV (air) IEC/EN 61 000-4-2

HF irradiation: 10 V / m IEC/EN 61 000-4-3

Fast transients: 4 kV IEC/EN 61 000-4-4

Surge voltages

between

wires for power supply: 2 kV IEC/EN 61 000-4-5

between wire and ground: 4 kV IEC/EN 61 000-4-5

Interference suppression: Limit value class B EN 55 011

#### Degree of protection

Housing: IP 40 IEC/EN 60 529

Terminals: IP 20 IEC/EN 60 529

**Housing:** Thermoplastic

**Vibration resistance:** Amplitude 0.35 mm, frequency 10 ... 55 Hz, IEC/EN 60 068-2-6

## Technical Data

**Climate resistance:** 20 / 060 / 04 IEC/EN 60 068-1

**Terminal designation:** EN 50 005

**Wire connection** DIN 46 228-1/-2/-3/-4

**Screw terminals (integrated):** 1 x 4 mm<sup>2</sup> solid or 1 x 2.5 mm<sup>2</sup> stranded ferruled (isolated) or 2 x 1.5 mm<sup>2</sup> stranded ferruled (isolated) or 2 x 2.5 mm<sup>2</sup> solid

Insulation of wires or sleeve length: 8 mm

#### Plug in with screw terminals

max. cross section for connection: 1 x 2.5 mm<sup>2</sup> solid or 1 x 2.5 mm<sup>2</sup> stranded ferruled (isolated)

Insulation of wires or sleeve length: 8 mm

#### Plug in with cage clamp terminals

max. cross section for connection: 1 x 4 mm<sup>2</sup> solid or 1 x 2.5 mm<sup>2</sup> stranded ferruled (isolated)

min. cross section for connection: 0.5 mm<sup>2</sup>

Insulation of wires or sleeve length: 12 ±0.5 mm

**Wire fixing:** Plus-minus terminal screws M 3.5 box terminals with wire protection or cage clamp terminals

**Fixing torque:** 0.8 Nm

**Mounting:** DIN rail IEC/EN 60 715

**Weight** 160 g

### Dimensions

#### Width x height x depth

LG 3096: 22.5 x 90 x 121 mm

LG 3096 PC: 22.5 x 111 x 121 mm

LG 3096 PS: 22.5 x 104 x 121 mm

MK 3096N: 22.5 x 90 x 102 mm

MK 3096N PC: 22.5 x 111 x 102 mm

MK 3096N PS: 22.5 x 104 x 102 mm

### Classification to DIN EN 50155 for MK 3096N

#### Vibration and

**shock resistance:** Category 1, Class B IEC/EN 61 373

**Protective coating of the PCB:** No

### CSA-Data for LG 3096

**Switching capacity:** 3A 250Vac

#### Wire connection:

Fixed screw terminal: 60°C / 75°C copper conductors only AWG 20 - 12 Sol/Str Torque 0.8 Nm

Plug in screw terminal: AWG 20 - 14 Sol Torque 0.8 Nm AWG 20 - 16 Str Torque 0.8 Nm

Plug in cage clamp terminal: AWG 20 - 12 Sol/Str Torque 0.8 Nm



Technical data that is not stated in the CSA-Data, can be found in the technical data section.

### CCC-Data for MK 3096N

**Thermal current  $I_{th}$ :** 4 A

#### Switching capacity

to AC 15: 1,5 A / AC 230 V IEC/EN 60 947-5-1

to DC 13: 1 A / DC 24 V IEC/EN 60 947-5-1



Technical data that is not stated in the CCC-Data, can be found in the technical data section.

## Standard Types

LG 3096.60 DC 24 V

Article number: 0056147  
 • Output: 5 NO and 1 NC contacts  
 • Width: 22.5 mm

MK 3096N.60 DC 24 V

Article number: 0055931  
 • Output: 5 NO and 1 NC contacts  
 • Width: 22.5 mm

## Variants

LG 3096.\_\_/004

MK 3096N.\_\_/004: With gold plated contacts to switch low loads.  
 Because of the gold plated contacts the MK 3096N.\_\_/004, LG 3096.\_\_/004 can be used to switch small loads 1 mVA ... 7 VA, 1 mW ... 7 W in the range of 0.1 ... 60 V, 1 ... 300 mA. The gold plated contacts allow also to switch the maximum current but the gold plating will be burnt off. After that the contacts cannot be used any more to switch the small loads.

LG 3096.\_\_/300:

AC-units

LG 3096.\_\_/304:

AC-units with gold plated contacts with CSA-approval (Canada/USA), on request

LG 3096.\_\_/\_\_\_/60:

MK 3096N/100:

2 contacts switched internally in series.

MK 3096N:

with CCC-approval on request

## Ordering example for variants

MK 3096N. PS/ DC 24 V

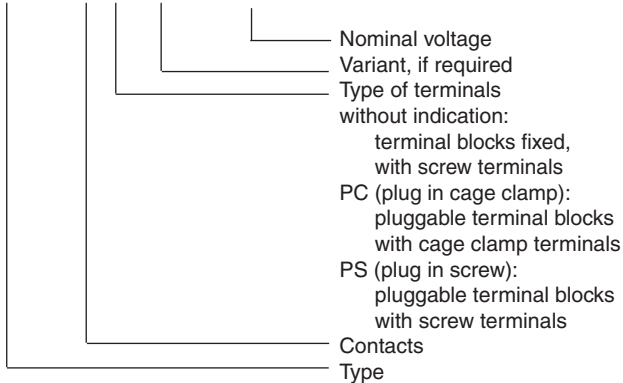

## Options with Pluggable Terminal Blocks

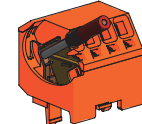
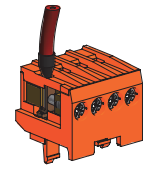
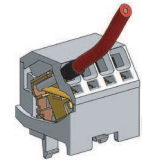
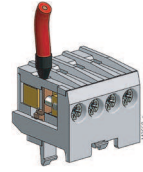

Screw terminal (PS/plugin screw)

Cage clamp terminal (PC/plugin cage clamp)

## Notes

Removing the terminal blocks with cage clamp terminals

1. The unit has to be disconnected.
2. Insert a screwdriver in the side recess of the front plate.
3. Turn the screwdriver to the right and left.
4. Please note that the terminal blocks have to be mounted on the belonging plug in terminations.

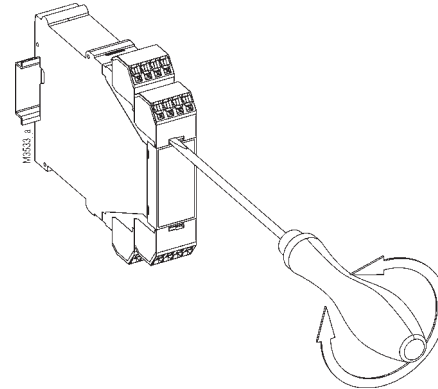

## Characteristic

